

## USER GUIDE

### LED LIGHTED MIRROR W/BUILT- IN MAGNIFIER AND CLOCK



Model: L63434040-1

# IMPORTANT SAFETY INFORMATION

Please read through this installation instruction so you will know how to install and operate your model properly. Keep this document in a safe place for future reference after use.

## **WARNING**

This product must be installed in accordance with the installation instruction by qualified technician. Failure to follow instruction could result in death or serious bodily injury.

## **CAUTION**

This product must be serviced by qualified personnel. ALWAYS unplug the power cord or turn off the circuit breaker before service.

# PACKAGE CONTENTS

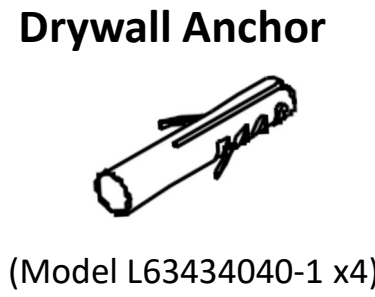
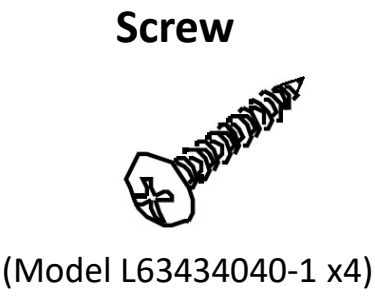
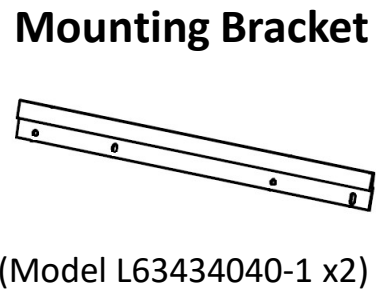
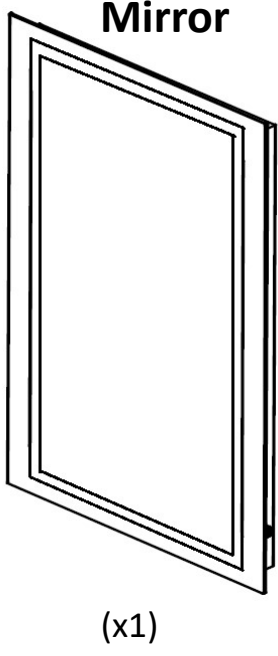

# INSTALLATION

1

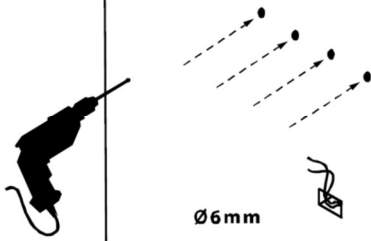

For drywall installation, mark the hole locations and drill  $\Phi$  6mm holes for the drywall anchors. Install a junction box behind the mirror for power connections.

2

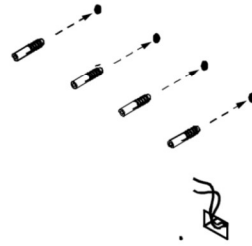

Insert provided drywall anchors.

3

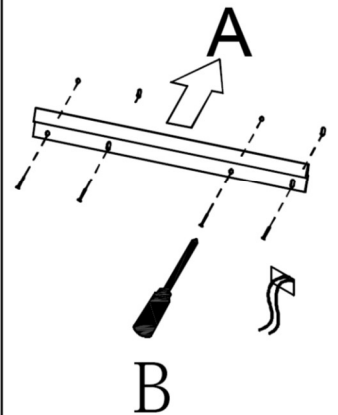

Install the mounting bracket.

4

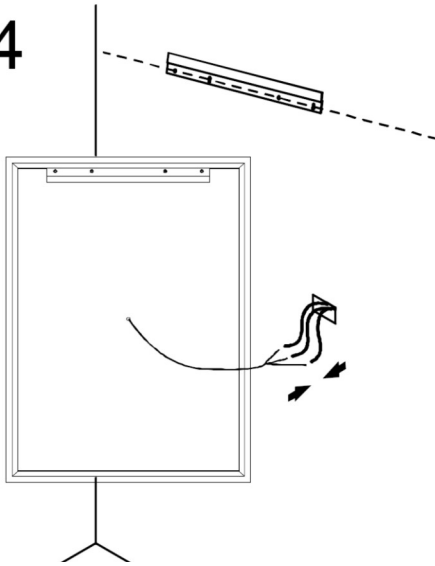

Connect to 110V power supply

5

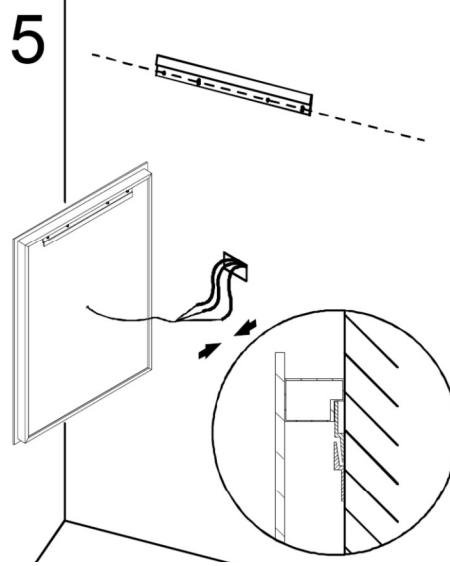

Hang the mirror to the wall and make sure the bracket in the back of the mirror lineup with the mounting bracket properly.

6

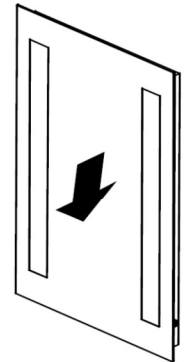

Press the mirror down slightly and make sure the brackets fit properly.



- Using the wall studs to hang the mirror is highly recommended.
- This mirror is NOT designed to work with wall switch. The built in digital clock will need to be reset if the power to the mirror is cut off.

# INSTALLATION DIMENSIONS

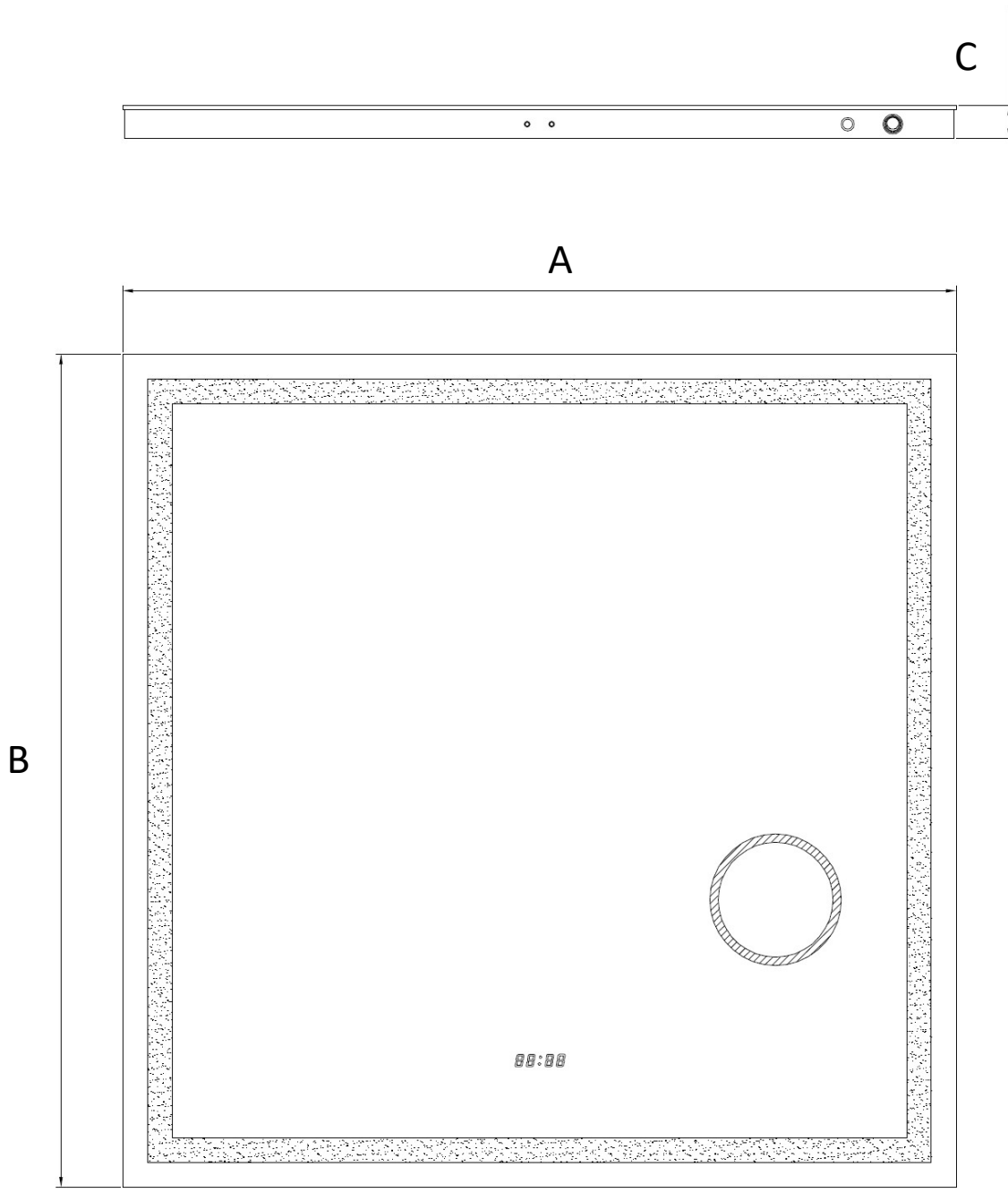

Model #	A	B	C
L63434040-1	40	40	1 5/8

# BASIC OPERATION

## 1. Rocker switch

- a. Turn switch to <-> position to turn on the lights.
- b. Turn switch to < o > position to turn off the lights.

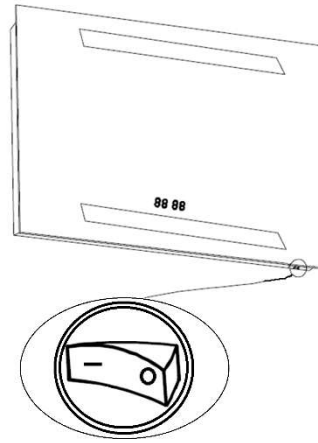

## 2. Setting the clock

- a. To change the hour, press the button on the left.
- b. To change the minute press the button on the right.

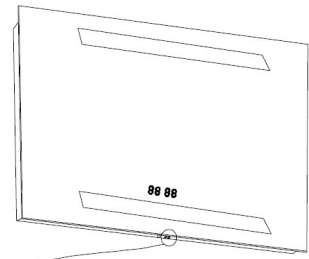
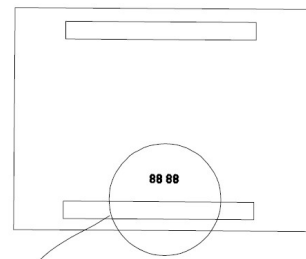

a.

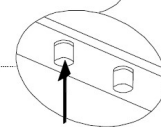

b.

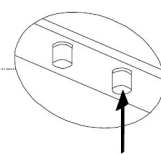

**Please note that the built in digital clock will need to be reset if the power to the mirror is cut off. Therefore, we do NOT recommend wiring the product to a wall switch.**

## CARE AND MAINTENANCE

Clean the mirror with a soft, damp cloth and dry thoroughly with a soft towel. Do NOT allow the edges of the mirror to get or remain wet over a period of time. Please do NOT use glass cleaner that contains ammonia or vinegar. Never spray any cleaner directly onto a mirror. Instead apply the cleaner to a soft cloth and then wipe the mirror. Make sure no commercial cleaner comes in contact with the edge or backing.

## WARRANTY

### 5 years Limited Warranty

**innoci usa** LED mirrors (Illumirror®) have been manufactured under the highest standards of quality and workmanship. We warrant to the original purchaser that our LED mirrors are free from any defects in material and workmanship by normal use for 5 years from date of purchase. A replacement for any defective part will be supplied FREE OF CHARGE for installation by you.

This warranty is valid to the original purchaser only and does not cover product damage due to installation error, product abuse, product misuse, etc. whether or not performed by professionals. **innoci usa** will not be responsible for labor charges and/or damage incurred in installation, repair or replacement nor for any incidental or consequential damages.

All warranty claims should be sent to [customerservice@innoci-usa.com](mailto:customerservice@innoci-usa.com) or call 1.866.479.8076. Our customer service representative will contact you promptly to help you go through the process until you are completely satisfied with our products.

**SHORTAGE OR DAMAGED PRODUCTS** All shipments are carefully inspected and counted before leaving our distribution centers. Please inspect carefully on receipt of merchandise, noting any discrepancy or damage on the carrier's freight bill at that time, and file a claim with the carrier within 10 days from receipt of order. Then contact our office. Deductions from invoices for shortages or damage claims will not be allowed.

**RETURN NEW GOODS** All claims for returns or adjustments must have prior approval and return authorization (RA) number. Only original, sealed product in salable condition are eligible for return. Credit for authorized returns will be issued at the net price paid for the product and subject to a 15% restocking/handling fee. Merchandise is to be returned via prepaid freight. All unauthorized returns will be refused or subject to a 25% restocking/handling fee.

To request an "RA" number: Contact our Customer Service Representatives at [customerservice@innoci-usa.com](mailto:customerservice@innoci-usa.com). We will send you a Return Authorization Number (RA) by return email. Please take necessary precautions when returning merchandise to prevent additional damage. Insurance is the responsibility of the shipper.

# Exploded view

Part	Description
1	Mirror
2	Magnifier
3	Rocker Switch
4	Clock Dials
5	Aluminum Frame
6	Clock Unit
7	Connection Box
8	Clock Driver
9	LED Driver
10	LED Strip Support
11	LED Strip
12	Galvanized Plate
13	Cable Gland
14	Mounting Bracket

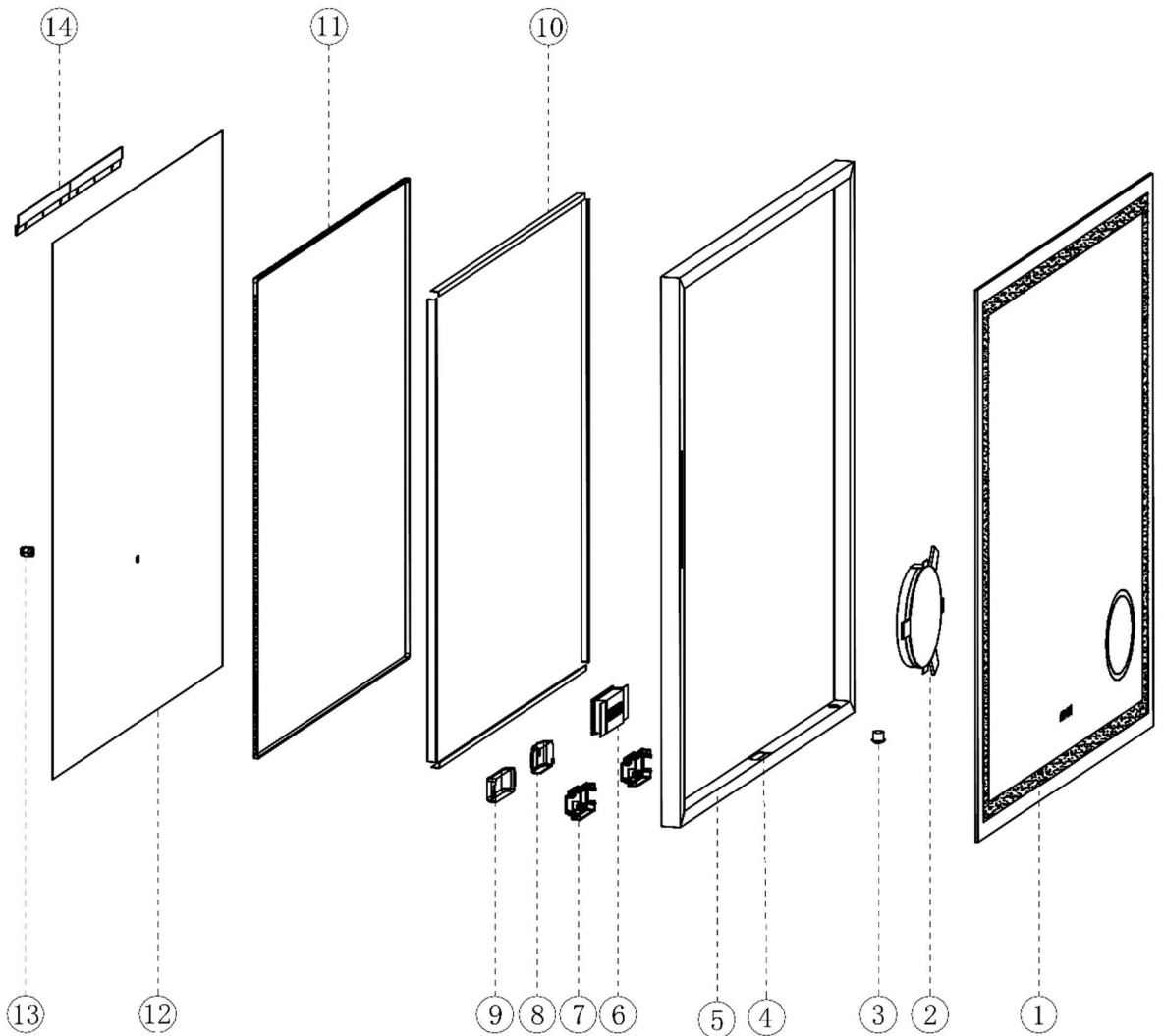

**innoci usa, Inc.**

14530 Best Ave.,  
Santa Fe Springs, CA 90670

[www.innoci-usa.com](http://www.innoci-usa.com)